

※Thank you for selecting this series solar charge controller, please read this specification before using the product.  
※Please keep this specification for the further reference.

## MPPT SOLAR CONTROLLER

### 1. OVERVIEW:

Thank you for selecting MPPT series solar charge controller with the most advanced MPPT control algorithm and the maximum power point of the pv array can be quickly tracked in any environment so that it can get the maximum energy from the solar panel and significantly improve the utilization of energy in solar system. The machine has the dual display function of LCD and Remote header (optional) and standard communication interface, convenient for user extension application and satisfy different monitoring needs to the maximum extent. It can be used in communication base station, home power supply system, traffic light, solar street lamp, courtyard lamp system, etc. The

- Advanced MPPT maximum power point tracking technology, the tracking efficiency is no less than 99.5%.
- High quality components are used to improve the system performance, and the maximum conversion efficiency can reach 97%.
- Super fast maximum power tracking speed while ensuring tracking efficiency.
- Accurate identification and tracking of the maximum power point of multi-wave peak.
- Reliable maximum input power of pv array to ensure the safety of equipment.
- Wide pv array maximum power point operating voltage range.
- 12/24v automatic voltage identification
- The LCD is designed to dynamically display the operation data and working status of the equipment.
- Various load control modes: general mode, light control mode, dual time mode, pure charger mode and timing mode.
- Seal, GEL, Flooded, LifePO4 and Li(NiCoMn)O2 charging process can be selected.
- The function of battery temperature compensation.
- Power statistics recording function.
- Use the RS485methods to maximize the communication needs of different occasions.
- Support PC monitor, external display unit and other peripherals, realize real-time data view and parameter setting function.

### 2. PRODUCT APPEARANCE:

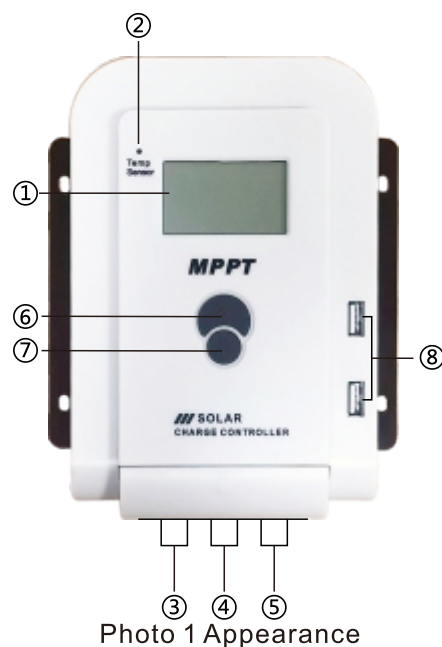

1

①	LCD
②	Temperature sensor interface(Selection)
③	Photovoltaic array terminals
④	Battery terminal
⑤	Load terminal
⑥	Menu Button
⑦	Set Button
⑧	USB output

**NOTICE:** In the case of the remote temperature sensor not connected, the controller will compensate the charging parameters by 25°C for the battery temperature.

### 3. WIRING

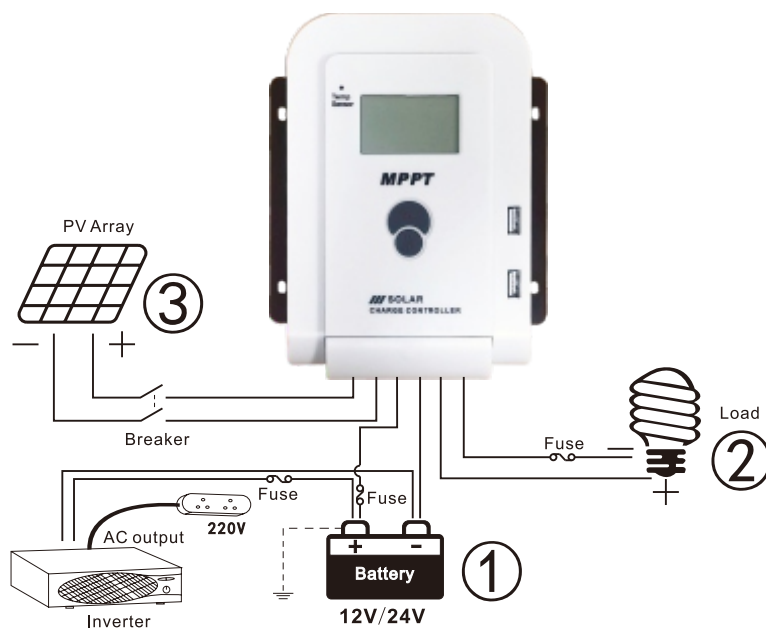

Photo 2 Connection diagram

#### Order of connection:

- ①Connect battery  
**Notice: The battery terminal shall be installed with insurance, and the installation distance shall not exceed 50mm.**
- ②Connected Load
- ③Connect pv array
- ④Controller is powered on

Connect the battery, identify the voltage of the control system and observe whether the display screen is lighted. If it doesn't work or the display is abnormal, refer to section 6 for troubleshooting.

**NOTICE:** This series of MPPT is a common positive controller, pv array, battery and load of the positive pole can be grounded at the same time.

**NOTICE:** If the inverter or other starting current is loaded in the system, please connect the inverter directly to the battery. Do not connect with the controller's load terminal.

2

### 4. IN TERDACE DESCRIPTION

#### 4.1Buttons

Mode	Remarks
load switch	When the load is manual mode, by short pressing set button can switch the load.
Breakdown	Pressing the set button shortly
Browse mode	Pressing the menu or set button shortly
Setting mode	Long press menu button enter the secondary browsing interface and then press menu or set button to browse interface, long press menu again to enter the setting mode, short press menu or set button to set parameters then long press menu button to save the setting Long press set button or 20s without keystroke operation will exit secondary browsing interface (parameter not saved)

#### 4.2 LCD

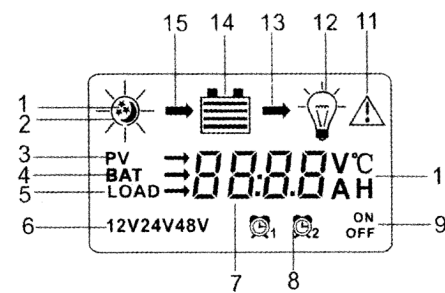
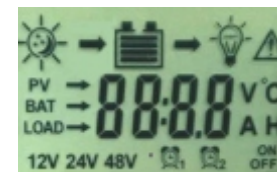

1. The default night display of controller:  
When the solar panel input voltage have been detected by controller less than sensor identification point voltage, this graphic symbol will be light.
2. The default daytime display of controller:  
When the solar panel input voltage have been detected by controller more than sensor identification point voltage, this graphic symbol will be light.
3. The indicator of PV array parameter:  
When the solar panels data was displaying, this graphic symbol will be light, for example the voltage of solar panel.
4. The indicator of battery parameter:  
When the battery parameter was displaying, this graphic symbol will be light, for example the voltage of battery, temperature of battery
5. The indicator of load parameter:  
When the load parameter was displaying, this graphic symbol will be light.
6. System voltage:  
When the LCD shows different system voltage, controller will adjust the technical data automatically.
7. Numerical display area
8. Timer setting function
9. Switch graphic symbol
10. Unit symbol value
11. Warning:  
When there is fault, this graphic symbol will be light.
12. The indicator of load status:  
Load on, Load off.
13. The indicator of output power:  
When the load terminal have output, this graphic symbol will be light.
14. The indicator of capacity of battery:  
When the battery was in different capacity, the strip-type will show.
15. The indicator of charge status:  
When the controller is charging, the symbol will be light, float charge will be flash, no charging no display.

3

### 5. INSTALLATION IMPORTANT NOTE

- 1) The controller should be installed well-ventilated place, avoid direct sunlight, high temperature and do not install in location where water can enter the controller.
- 2) Please select correct screw to fix the controller on the wall or other platform. Screw M4 or M5, screw cap diameter less than 10mm
- 3) Please reserve enough space between the wall and controller, to allow for cooling and cable connection.
- 4) The mounting holes distance is 155.8mm\*63mm, diameter of the hole is 5mm.
- 5) Connect components to the charge controller in the sequence, please pay much attention to the "positive" and "negative", don't insert the fuse or turn on the breaker during the installation. When disconnecting the system, the order will be reserved.
- 6) Always connect the battery first, in order to allow the controller recognize the system voltage.
- 7) The battery fuse should be installed as close to battery as possible.
- 8) The distance between the battery fuse to battery group is within 150mm
- 9) Positive grounding controller, any positive connection of solar load or battery can be earth grounded as required.
- 10) All terminals are in tight status after leaving factory, in order to well connected, please loose all terminals at first.
- 11) The sequence of connection please do not free change, otherwise cause system voltage recognition fault.
- 12) The length of cable between battery and controller as shorter as possible. Suggest 30cm to 100cm.
- 13) If short circuit happened on the terminals of controller, it will be result in fire or explode. Please be careful.  
(We strongly suggest to connecting a fuse at the battery side 1.5time of rated current of controller)
- 14) If the battery reverse connection, the output of controller also same with battery polarity, please do not connect any load with controller at that time, or the load and controller will be destroyed.
- 15) The voltage of solar panel is very high under sunshine, high voltage can cause injury or destroy controller, make sure PV/max under required safety MPP range.
- 16) Avoiding injury from load voltage, please close to the output of controller with button at first, then connected the load on the controller. The controller do not offer reverse connection protection for load, so please take care, reverse connection for load will be destroy bulb.

### 5. OPERATION STEPS

#### Main interface

- 1) The controller will have 1s initialization interface after electrified, then go into main interface.

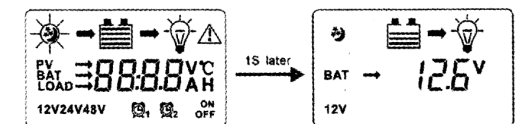

- 2) If no operation at main interface inner 20s, the main interface will be auto exchange during voltage of battery, voltage of solar panel, temperature of environment, each interface keep 3s. Long press "set" more than 5s at main interface, it will speed auto exchange. Loose button will stop speed.

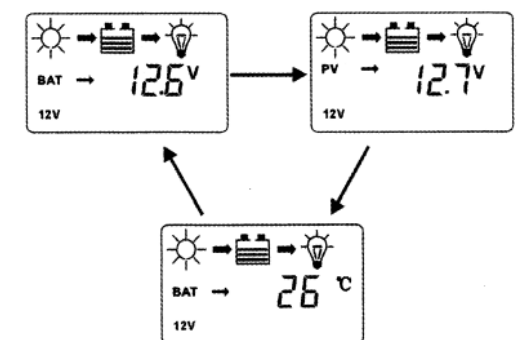

4

3) Press "set" under main interface could open or close

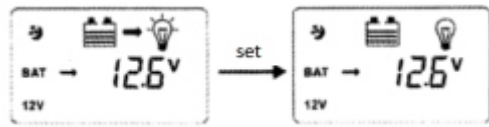

3) Press "menu" button could join into next menu under main interface.

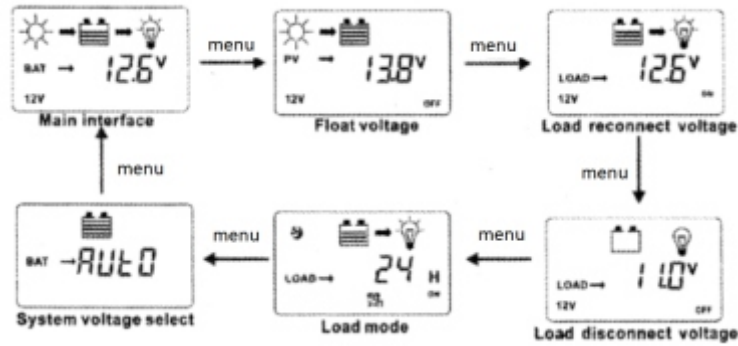

a) Float voltage set up

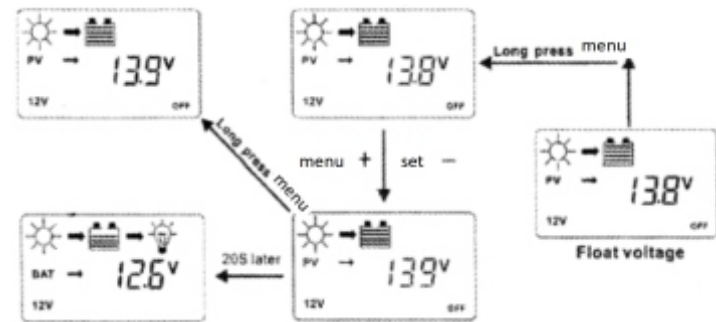

This parameter is high voltage disconnection (HVD) voltage. (Boost state voltage will be increase 0.6V base on HVD). The controller will be started PWM function at this point (HVD), limited voltage rising.

Press "menu" button join in float voltage menu. Long press "menu" button more than 5s, the parameter on the interface will be flash, here is set up state. Loose the button, press "menu" button again could operate plus data, press "set" button could operate minus data. After finish required technical data, long press "menu" button again more than 5s, the parameter save and come out set up state, if 20s no any operation, automatically back to main interface.

b) Low Voltage Reconnect Voltage (LVR)

When the voltage of battery is low, the control will stop offer power to the load. If the controller needs reconnected the output, the voltage of battery must be higher than LVD voltage or press "set" button force to release. The procedure is same with (a).

c) Low Voltage Disconnect Voltage (LVD)

When the voltage of battery is low, the load output will be cut off. When the controller detected the battery voltage was less than LVD point, the cut off function will be immediately working. At the same time, the status of controller is in lock. Users have to charge the battery, when the battery voltage is higher than LVD voltage or press "set" button force to release. The load output will be back. The procedure is same with (a).

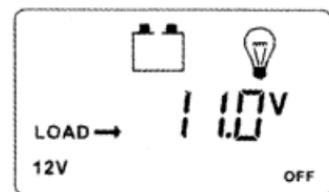

▲ Above a、b、c three parameter default data was fully considered by designer according to the actual use. Generally users don't need to adjust. Please must be refer to battery supplier's suggestion, or the battery will be damaged or irreparable destroy.

d) Load Working Mode Selection

The control default load working 24hours.

When the load working time set to 24hours, the load will keep working 24hours in no fault status.

When the load working time set to less than 23Hours, it means the load start timer or sensor function. If the battery capacity is enough, the load will be started at sunset. The load will work under timer setting hours or stop working till sunrise.

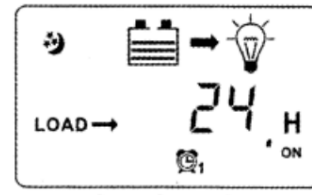

Load mode

▲ When the load join into timer or sensor mode, if the reset working time more than actual night time, the load output will be closed at sunrise, although the working time is not reach to setting hours, for example, the local actual night time is 10hours, user reset the working time at night is 12hours, but 10hours later the output will be closed automatically, the balance hours will be back to zero. The load will be working with next sunset signal.

e) System Voltage Select

This parameter designed for customers wide range voltage requiring, the default display "UTO" system voltage 12V/24V Auto. When battery voltage is more than 18V, the controller will be auto change to 24V system with 24 control data. When battery voltage is less than 18V, the controller will be auto change to 12V system with 12V control data. If the system voltage is set to "1", the controller will be work under 12V version forever. The battery voltage is not valid. The reset data will be working after reconnection. If the system voltage is set to "2", the controller will be work under 24V version forever. The battery voltage is not valid. The reset data will be working after reconnection.

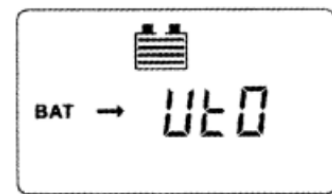

System voltage select

## 6. PROTECTION

**Battery Low Voltage Protection (LVD)**

When the battery voltage less than 11V, the LVD protection started. The output cut off, at the same time the battery symbol and warning flash. Please increase charge current or increase charge time. When the battery voltage more than 12.6V, the protection will be closed. The load output is come back or press "menu" button force to unlock main interface.

**Battery Over Voltage Disconnection (OVD)**

When the voltage of battery more than 16.5V, the over voltage protection will be started. The load cut off, at the same time the load and warning symbol flash. When the voltage of battery was decreased to 15V, the protection will be release. The output of the load is back.

**Load Over Current Protection**

When the load is short circuit or overload, the output cut off, at the same time the load symbol and warning flash. Please confirm if there is short circuit on the load terminal, decrease the power of the load. 30s later the controller will be auto restart with unlock, or press "menu" button force to unlock at main interface.

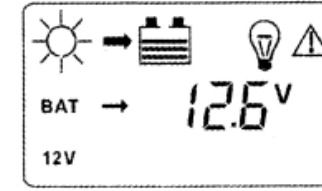

**High Voltage Disconnection Protection**

When the battery was charged to 13.8V, the PWM function will be started, the charge symbol will be flash, and the voltage of battery has been limited.

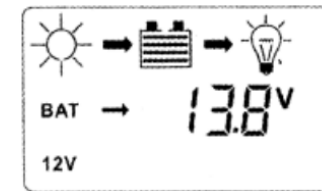

## 7. COMMON FAULT

Cause	Correction
Solar panel is disconnected	Check if connection of solar input is right and contact is reliable.
1. Battery voltage is less than 8v 2. Voltage of solar panel is less than battery voltage	1. Check battery voltage. Controller will start only Battery voltage is more than 8v 2. Voltage of solar panel must be more than battery voltage.
Battery Over-discharge	Load output is turned off automatically and recovers when battery electricity is enough.
Over voltage of storage battery	Please check whether the battery voltage exceeds the voltage and reconnect the solar panel.
Over-load	Reduce load or check load connection
Over temperature	Make the controller cool down and restart charging automatically.
Charging current of solar panel is too large	Check power of solar panel and reduce quantities of solar panel in parallel; Restart after 2 minutes..
The Controller display LVD	The battery is over discharge, Check the system design is reasonable or not, if there is discharging capacity more than charging capacity
The Controller display HVD	The voltage of battery is high, Cut off the solar panel and see if the voltage get down normal, if the fault still there then cut off the battery and reconnect it again
The controller display OCP Over current protection	The load is short circuit or over load or high surge power check the load cables have short circuit, the power of the load over rated design, the surge power of load too high

## 8. TECHNICAL SPECIFICATIONS

Model No.	MPQ					
Rated charge current	10A	20A	30A	40A	50A	60A
System rated voltage	12V/24V Auto work					
Voltage range of battery	8-32V					
Max open voltage of PV module	75V					
Battery type	User default, Sealed, Flooded, GEL, LiFePO4					
Equalized charging voltage	Maintenance-fee lead acid battery 14.6V, GEL: No; Lead acid flooded battery: 14.8V					
Absorption charging voltage	Maintenance-fee lead acid battery 14.4V, GEL: 14.2; Lead acid flooded battery: 14.6V					
Floating charging voltage	Maintenance-fee lead acid battery, GEL, Lead acid flooded battery: 13.8V					
Low voltage re-connection (LVR)	Maintenance-fee lead acid battery, GEL, Lead acid flooded battery: 12.6V					
Low voltage disconnection (LVD)	Maintenance-fee lead acid battery, GEL, Lead acid flooded battery: 10.8V					
Static loss	≤ 9.2mA 12V; ≤ 11.7mA 24V; ≤ 13.2mA 48V					
High voltage disconnection (HVD)	16V (24V x 2; 48V x 4)					
Duration of absorption charging	2Hours	Duration of equalized charging			2Hours	
Light control voltage	5V	Temperature compensation coefficient			-4mV/°C(25°C)	
Charge loop voltage drop	≤ 0.29V	Discharge loop voltage drop			≤ 0.16V	
LCD Temperature	-20°C~+70°C		Storage Temperature		-30°C~+80°C	
Operating Temperature	-20°C~+55°C (To run at full rated current continuously)					
Working humidity	≤ 95% No condensation					
Protection class	IP30	Grounded type			Positive grounded	
Dimension (LxWxH) mm	175 x 140 x 41		216 x 170 x 69			
Color box size (LxWxH) mm	198 x 148 x 50		230 x 180 x 79			
Quantities per Carton (pcs)	40		20			
Packing size (LxWxH) cm	51 x 41.5 x 31.5		47.5 x 41 x 38			
Gross weight / Net weight (kg)	20.5 / 19.6		22 / 20.5			